



TECHNOLOGIES

**TELECOMMUNICATION**  
DT RF & Microwave Product



## Low Noise Amplifier

1200 to 2500 MHz

Part Number: **LNA-1200-2500-SF**

Application: Cellular, PCS, Communication Receivers  
& Transmitters, Satellite Communication, Military

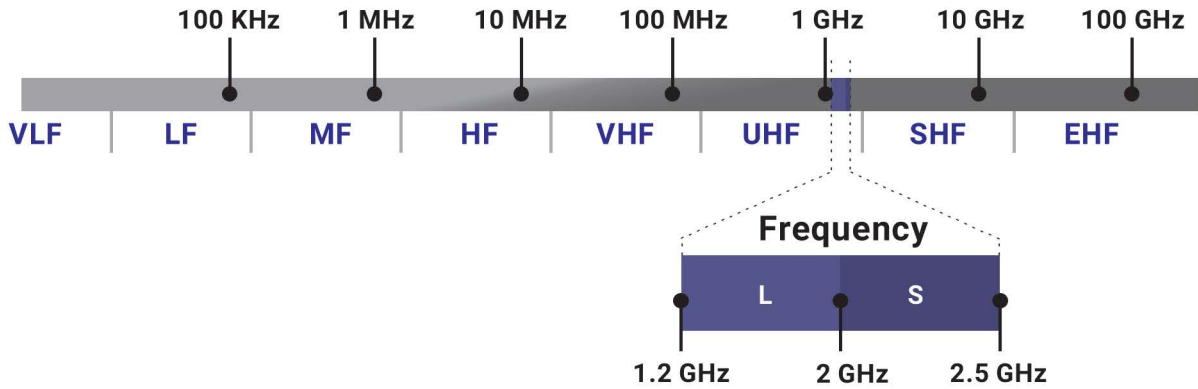

Parameter	Min.	Typ.	Max.	Units
Gain	17	-	23	dB
Noise Figure	-	0.5	-	dB
Output P1dB	-	18	-	dBm
Output IP3	-	32	-	dBm
Input Return Loss	12	-	-	dB
Output Return Loss	10	-	-	dB
Operating Voltage	4.5	5	5.5	V
Operating Current	-	55	-	mA
Input Power	-	15	-	dBm
Operating Temperature	-40	-	85	°C
Connector Type	SMA Female			
<b>Absolute Maximum Rating</b>				
Source Voltage	-	+5.5	-	V
RF Input Power	-	+17	-	dBm
Storage Temperature	-45	-	95	°C



# Typical Performance Curves

Input Return Loss =  $-S_{11}$  (dB)

Gain (Power Gain) =  $S_{21}$  (dB)

Reverse Isolation =  $-S_{12}$  (dB)

Output Return Loss =  $-S_{22}$  (dB)

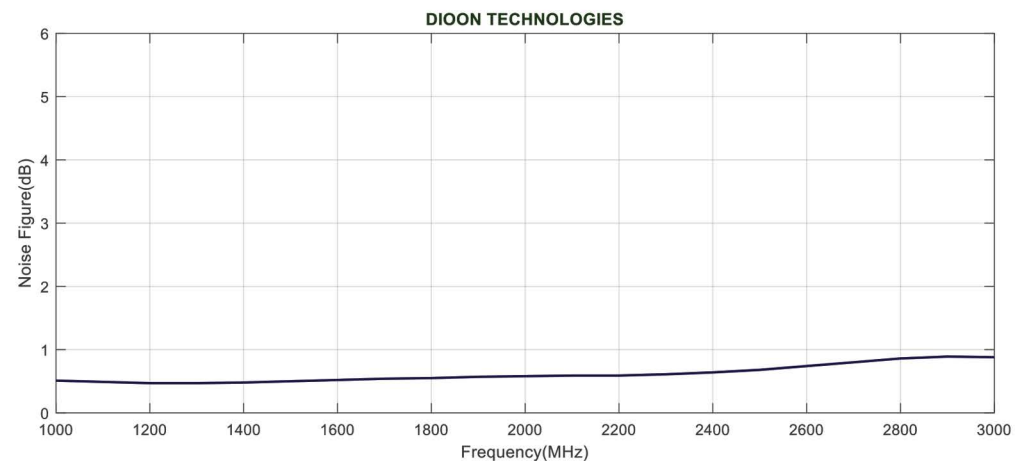
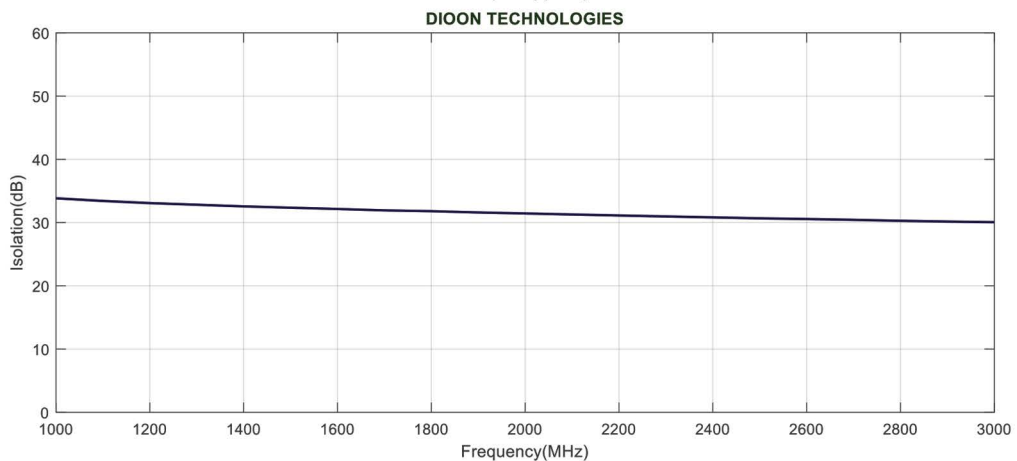
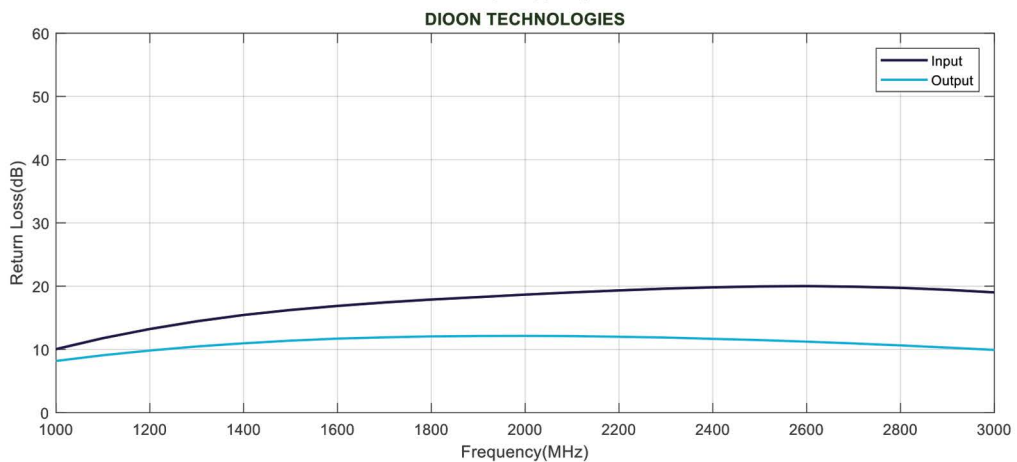
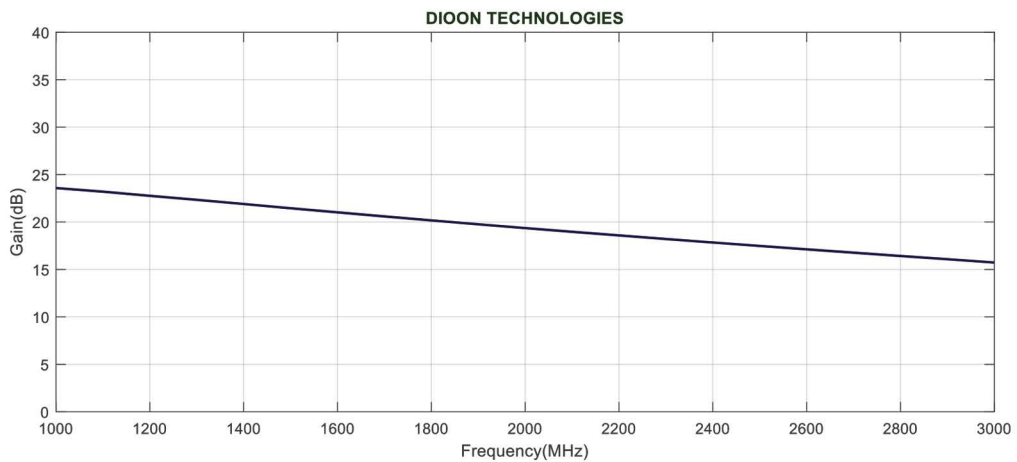

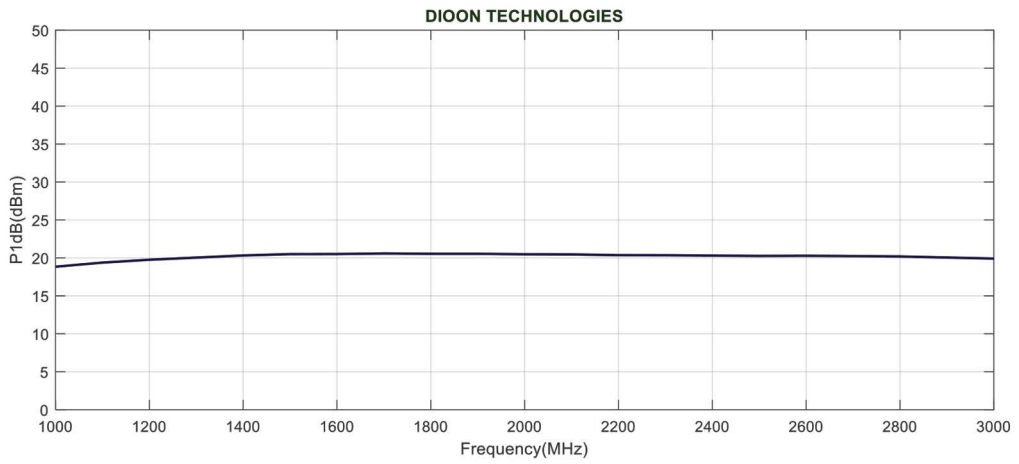
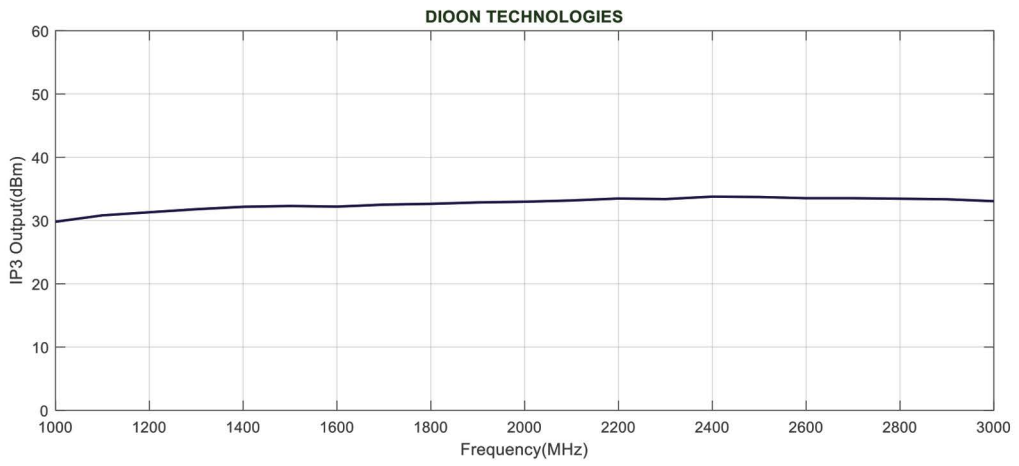

## CAD Drawing

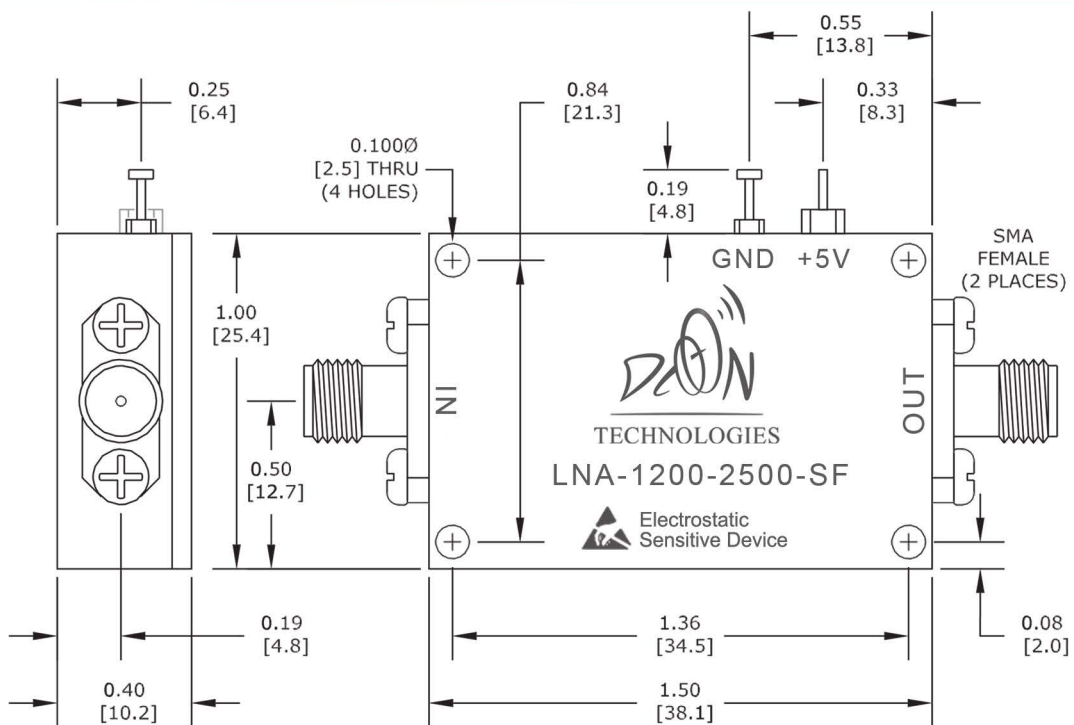

**NOTE:**

- ▶ Unless Otherwise Specified All Dimensions Are Nominal.
- ▶ All Specifications Are Subject To Change Without Notice At Any Time.
- ▶ Dimensions Are In Inches (mm).



TECHNOLOGIES

Phone: +1(949)508 0037  
Email: Sales@dioon.us

**DIOON TECHNOLOGIES**

**WWW.DIOON.US**

The Advanced Way

United States Office  
660 Wald, Irvine, CA92618