



TECHNOLOGIES

TELECOMMUNICATION

DT RF & Microwave Product



Low Noise Amplifier

40 to 6000 MHz

Part Number: **LNA-40-6000-SF**

Application: Cellular, PCS, Communication Receivers
& Transmitters, Satellite Communication, Military

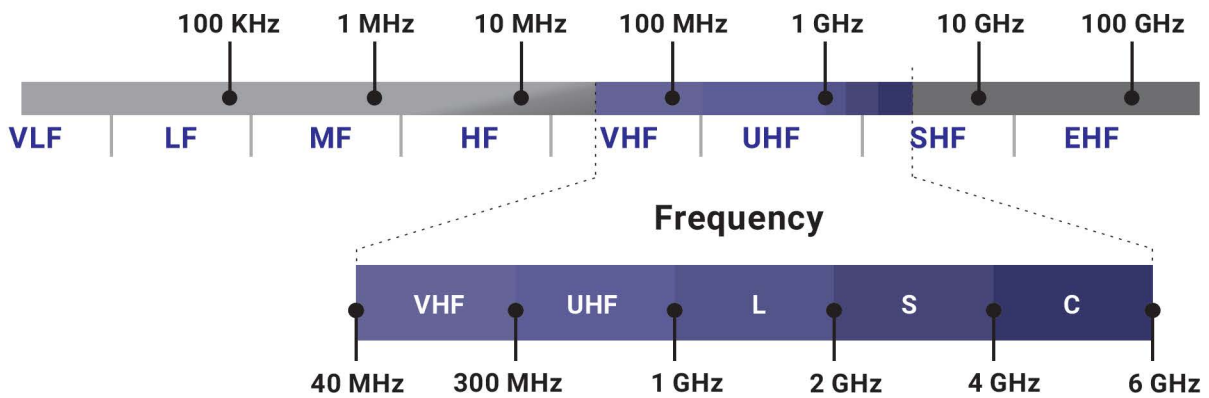

Parameter	Min.	Typ.	Max.	Units
Gain	.	16	.	dB
Gain Flatness	-	0.6	-	±dB
Noise Figure	-	3.6	-	dB
Output P1dB	-	14	-	dBm
Output IP3	-	26	-	dBm
Input Return Loss	12	-	-	dB
Output Return Loss	10	-	-	dB
Operating Voltage	4.5	5	5.5	V
Operating Current	-	60	-	mA
Input Power	-	8	-	dBm
Operating Temperature	-40	-	85	°C
Connector Type	SMA Female			-
Absolute Maximum Rating				
Source Voltage	-	+5.5	-	V
RF Input Power	-	+10	-	dBm
Storage Temperature	-45	-	95	°C



Typical Performance Curves

Input Return Loss = $-S_{11}$ (dB)

Gain (Power Gain) = S_{21} (dB)

Reverse Isolation = $-S_{12}$ (dB)

Output Return Loss = $-S_{22}$ (dB)

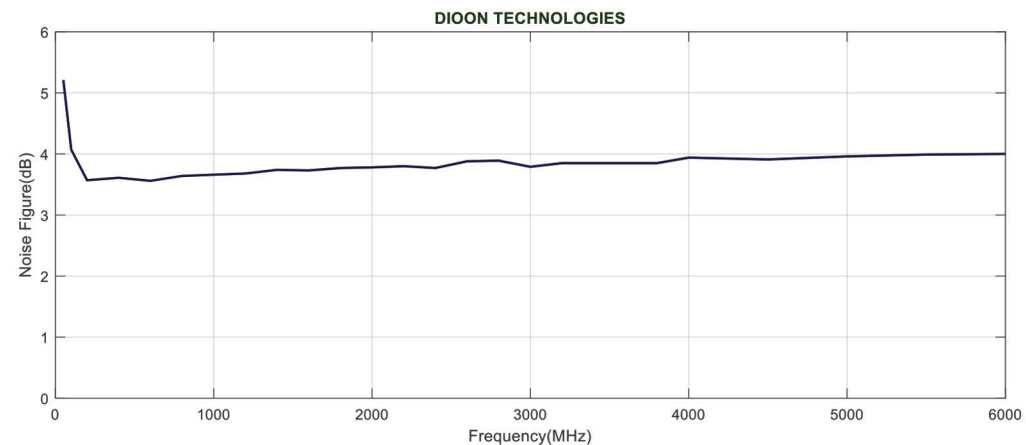
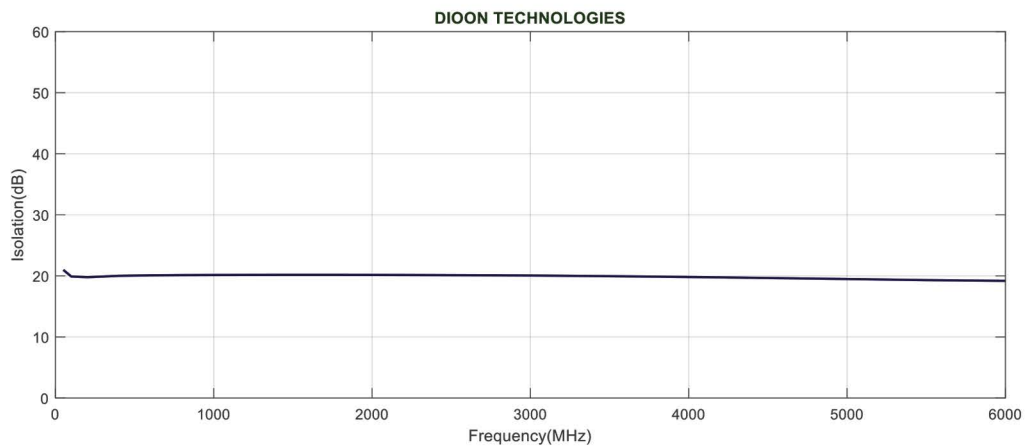
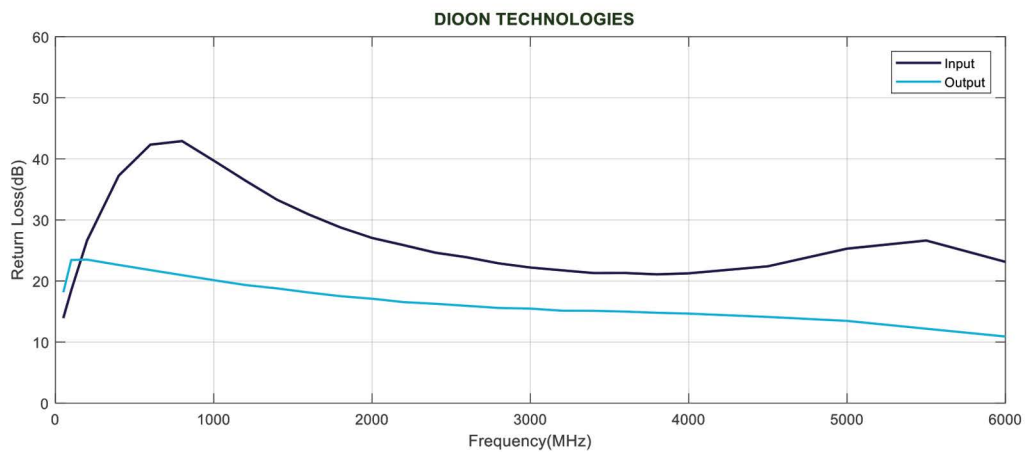
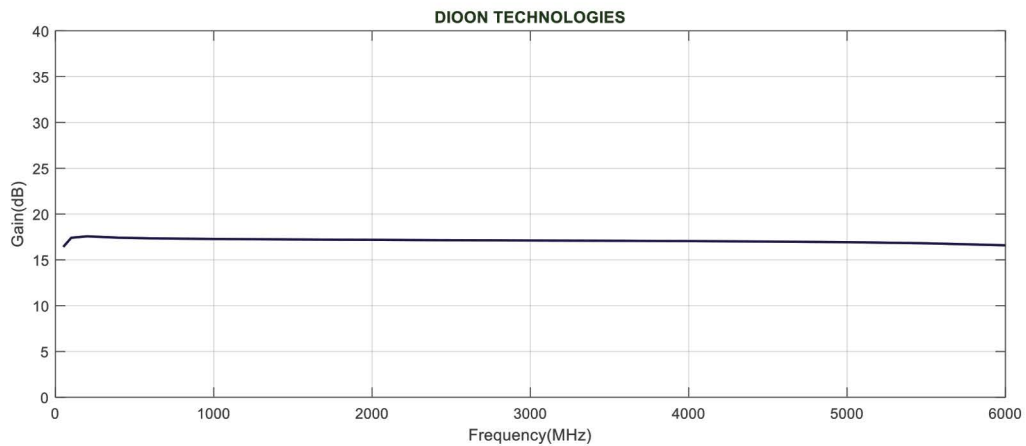

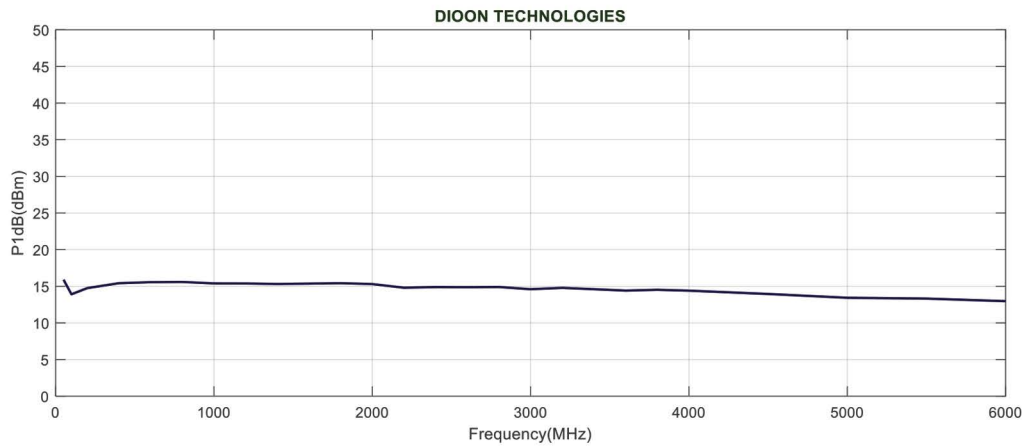
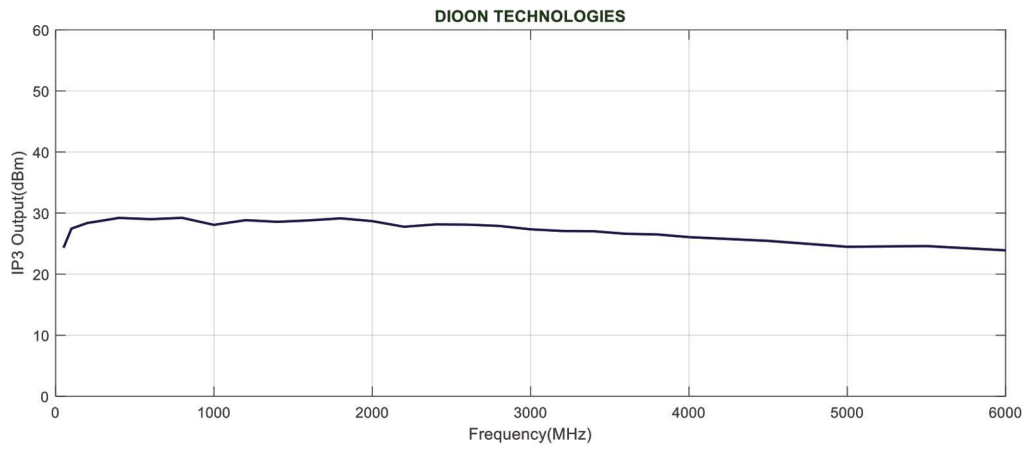

CAD Drawing

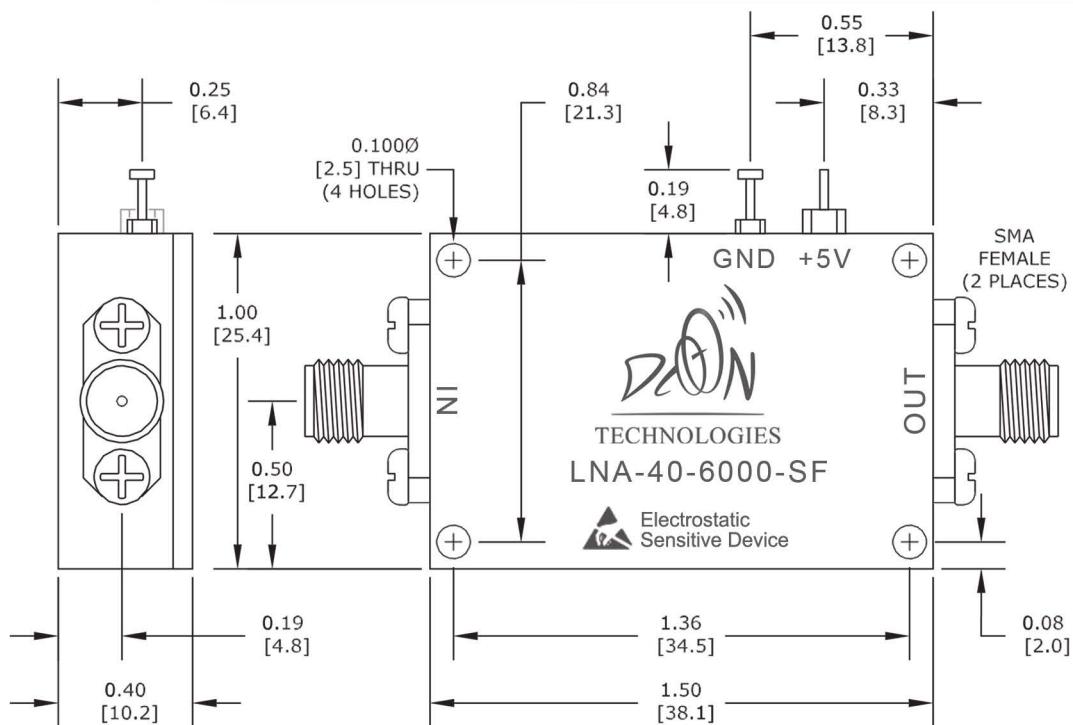

NOTE:

- ▶ Unless Otherwise Specified All Dimensions Are Nominal.
- ▶ All Specifications Are Subject To Change Without Notice At Any Time.
- ▶ Dimensions Are In Inches (mm).



TECHNOLOGIES

Phone: +1(949)508 0037
Email: Sales@dioon.us

DIOON TECHNOLOGIES

WWW.DIOON.US

The Advanced Way

United States Office
660 Wald, Irvine, CA92618